

Profec Kulventil PVC-U 90 mm limsocket 10bar DN80 grå type 2000 (0111383)



TEKNISKA SPECIFIKATIONER

Färg grå

Typ 2000

Material PVC-U

Funktion handtag

Handtagsfärg röd

Handtagsmaterial PVC-U

Hus konstruktion 3-delt

Materialhus PVC-U

Packningsmaterial PE/EPDM

Anslutning limsocket

Temperatur intervall 10°C - 60°C

Storlek 90 mm

DN 80

Tryck 10 bar

DIMENSIONER

Ct-1 165 mm

Lb 269 mm

R 215 mm

ØDf 80 mm

ØDi-1 90 mm

ØDi-2 90 mm

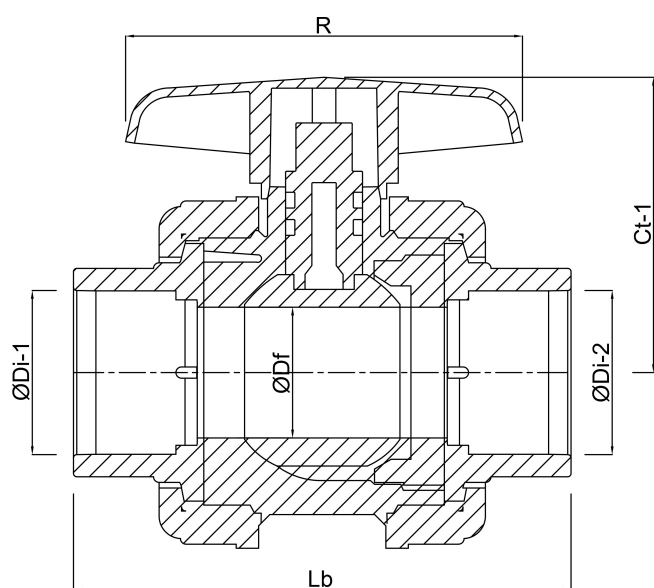

Genererad den: 20/02/2026

Bevo Nordic A/S
Pakhusgården 54
5000 Odense C
Danmark
+45 66 19 25 45
info@bevo.dk
<http://www.bevo.com>