

Böj 90° stål 120 mm x 120 mm x 2,0 mm svetsning (0200605)



TEKNISKA SPECIFIKATIONER

Material stål

Anslutning svetsning

Vägg tjocklek 2,0 mm

Storlek 120 mm

DIMENSIONER

Cb-1 350 mm

Cb-2 350 mm

ØDo-1 120 mm

ØDo-2 120 mm

β 90 °

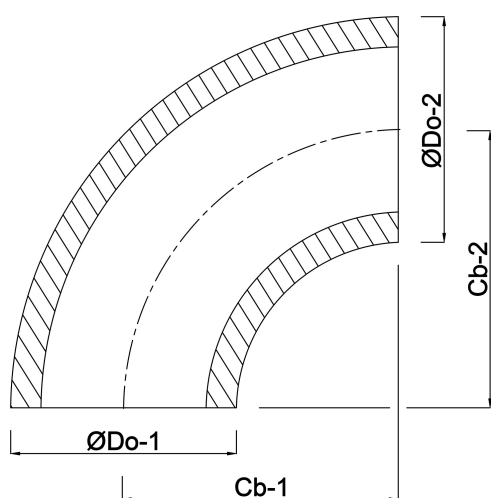

Genererad den: 22/02/2026

Bevo Nordic A/S
Pakhusgården 54
5000 Odense C
Danmark
+45 66 19 25 45
info@bevo.dk
<http://www.bevo.com>