

**Kulventil PVC-U 25 mm
limsocket 10bar DN20 grå type
2000 Teflon (0111907)**



TEKNISKA SPECIFIKATIONER

Färg	grå
Typ	2000 Teflon
Material	PVC-U
Funktion	handtag
Handtagsfärg	röd
Handtagsmaterial	PVC-U
Hus konstruktion	3-delt
Materialhus	PVC-U
Packningsmaterial	PTFE/EPDM
Anslutning	limsocket
Temperatur intervall	0°C - 60°C
Tryck	10 bar
Storlek	25 mm
Längd	108 mm
DN	20

DIMENSIONER

Ct-1 67 mm

Lb 108 mm

R 84.5 mm

ØDf 20 mm

ØDi-1 25 mm

ØDi-2 25 mm

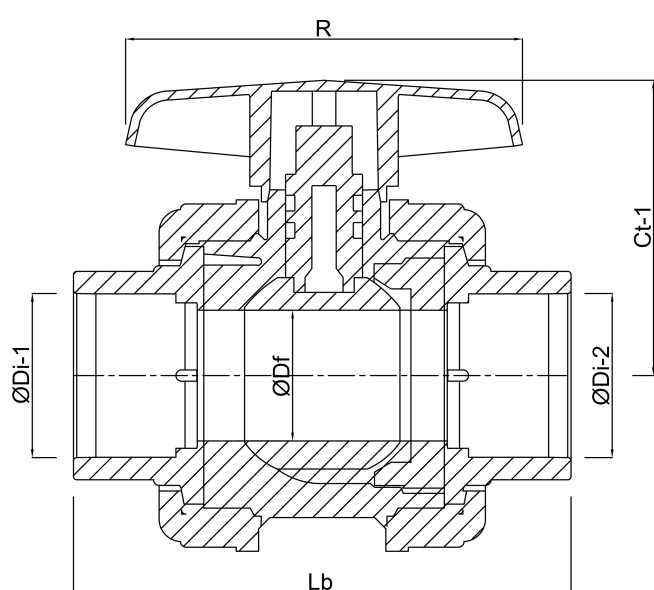

Genererad den: 20/02/2026

Bevo Nordic A/S
Pakhusgården 54
5000 Odense C
Danmark
+45 66 19 25 45
info@bevo.dk
<http://www.bevo.com>