

Profec Kulventil PVC-U 25 mm limsocket 16bar DN20 grå type 2000 (0111377)



TEKNISKA SPECIFIKATIONER

Färg grå

Typ 2000

Material PVC-U

Funktion handtag

Handtagsfärg röd

Handtagsmaterial PVC-U

Hus konstruktion 3-delt

Materialhus PVC-U

Packningsmaterial PE/EPDM

Anslutning limsocket

Temperatur intervall 10°C - 60°C

Storlek 25 mm

DN 20

Tryck 16 bar

DIMENSIONER

Ct-1 67 mm

Lb 108 mm

R 845 mm

ØDf 20 mm

ØDi-1 25 mm

ØDi-2 25 mm

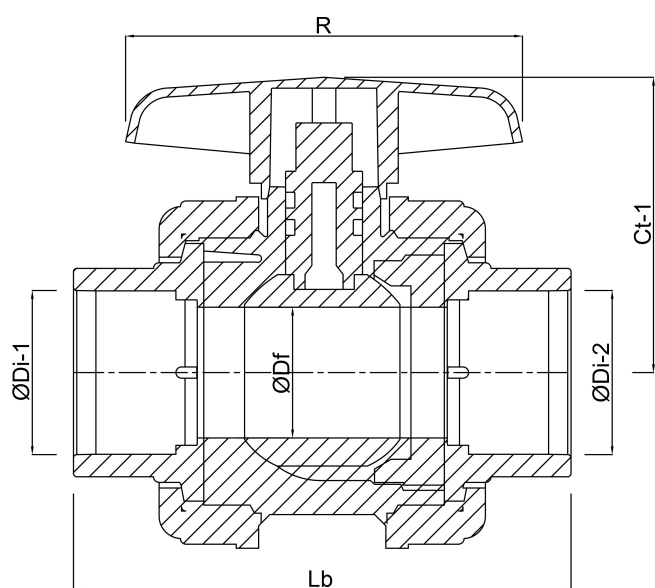

Genererad den: 20/02/2026

Bevo Nordic A/S
Pakhusgården 54
5000 Odense C
Danmark
+45 66 19 25 45
info@bevo.dk
<http://www.bevo.com>