

**Profec Flange PVC-U DN25 x 1"**  
**DIN flange x indvendig gevind**  
**16bar DN25 grå PN10/16**  
**(0111162)**

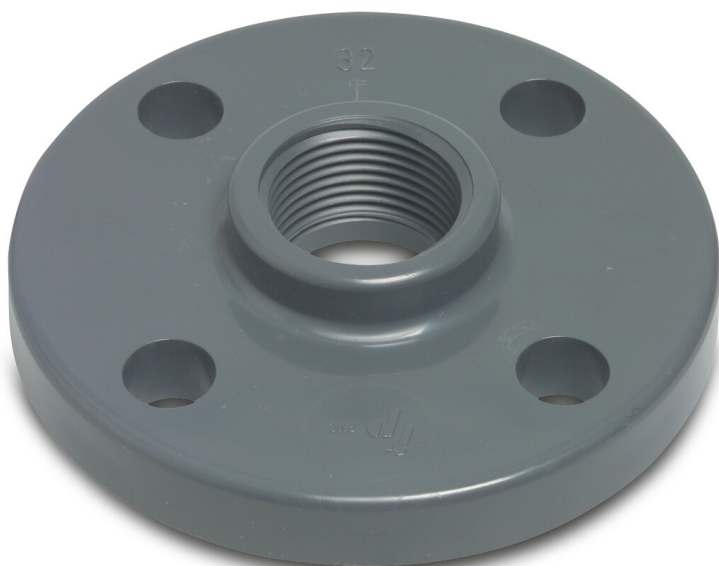

# TEKNISKE SPECIFIKATIONER

Farve	grå
Materiale	PVC-U
Tilslutning	DIN flange x indvendig gevind
Flange	PN10/16
Tryk	16 bar
Størrelse	DN25 x 1"
DN	25
Ydre Ø	115 mm
Vægt	0.142 kg
Tykkelse	14 mm
Bolthul	14 mm
Huller	4

## DIMENSIONER

O	14 mm
PCD	85 mm
ØDi-1	1 "

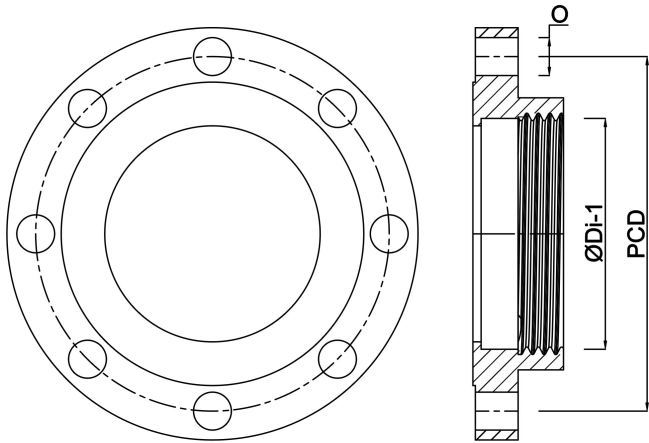

**Genereret den: 20-02-2026**

Bevo Nordic A/S  
Pakhusgården 54  
5000 Odense C  
Danmark  
+45 66 19 25 45  
[info@bevo.dk](mailto:info@bevo.dk)  
<http://www.bevo.com>