

Reduktionsbøsning PVC-U 80 mm x 125 mm limmuffe x studs grå (0360544)



TEKNISKE SPECIFIKATIONER

Farve	grå
Materiale	PVC-U
Tilslutning	limmuffe x studs
Anvendelse	regnvand
Størrelse	80 mm x 125 mm

DIMENSIONER

L	52 mm
ØDi-2	80 mm
ØDo-1	125 mm

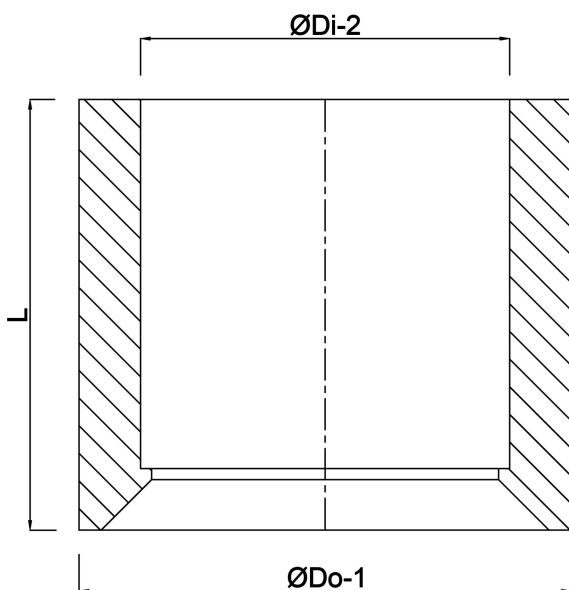

Genereret den: 10-10-2025

Bevo Nordic A/S
Pakhusgården 54
5000 Odense C
Danmark
+45 66 19 25 45
info@bevo.dk
<http://www.bevo.com>