

Profec Planflange stål DN50 x 60,3 mm DIN flange x stuksvejs 10bar PN10 (1180235)



TEKNISKE SPECIFIKATIONER

Materiale	stål
Tilslutning	DIN flange x stuksvejs
DIN Standard	DIN 2576
Flange	PN10
Tryk	10 bar
Størrelse	DN50 x 60,3 mm
Indre Ø	61,1 mm
Ydre Ø	165 mm
Vægt	2.46 kg
Tykkelse	18 mm
PCD	125 mm
Bolthul	18 mm
Huller	4

DIMENSIONER

O	18 mm
PCD	125 mm

ØDi-1

61.1 mm

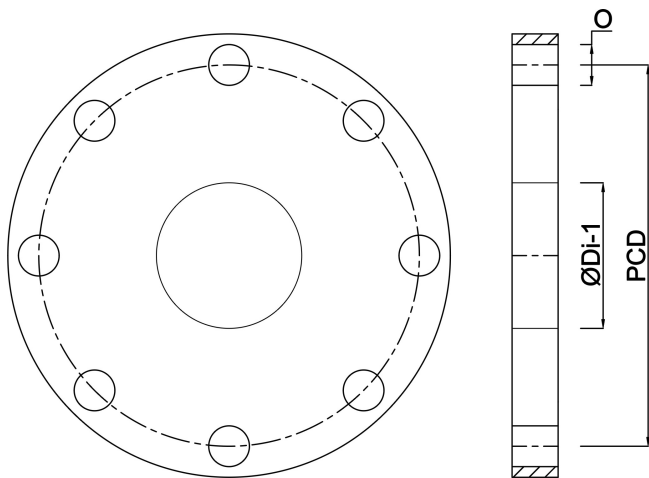

Genereret den: 22-02-2026

Bevo Nordic A/S
Pakhusgården 54
5000 Odense C
Danmark
+45 66 19 25 45
info@bevo.dk
<http://www.bevo.com>