

**Profec Gevind flange stål DN50
x 2" DIN flange x indvendig
gevind 16bar sort PN10/16
(1180215)**



TEKNISKE SPECIFIKATIONER

Farve	sort
Materiale	stål
Tilslutning	DIN flange x indvendig gevind
DIN Standard	DIN 2566
Flange	PN10/16
Tryk	16 bar
Størrelse	DN50 x 2"
Diameter	60,3 mm
Ydre Ø	165 mm
Vægt	2.41 kg
Højde	28 mm
Tykkelse	18 mm
PCD	125 mm
Bolthul	18 mm
Huller	4

DIMENSIONER

O 18 mm

PCD 125 mm

ØDi-1 2"

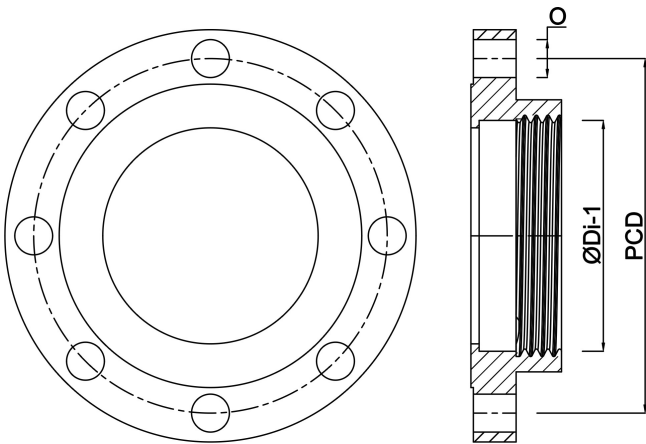

Genereret den: 22-02-2026

Bevo Nordic A/S
Pakhusgården 54
5000 Odense C
Danmark
+45 66 19 25 45
info@bevo.dk
<http://www.bevo.com>